

# ES700

## USER'S MANUAL



## WARNING

This equipment has been tested and found to comply with the limits for a Class A digital device, pursuant to Part 15 of FCC Rules. These limits are designed to provide reasonable protection against harmful interference when the equipment is operated in a commercial environment. This equipment generates, uses and can radiate radio frequency energy and, if not installed and used in accordance with the instruction manual, may cause harmful interference to radio communications. Operation of this equipment in a residential area is likely to cause harmful interference in which case the user will be required to correct the interference at his or her own expense.

**Caution:** Changes or modifications not expressly approved by the party responsible for compliance could void the user's authority to operate the equipment.

THIS DIGITAL APPARATUS DOES NOT EXCEED THE CLASS A LIMITS FOR RADIO NOISE EMISSIONS FROM DIGITAL APPARATUS AS SET OUT IN THE RADIO INTERFERENCE REGULATIONS OF THE CANADIAN DEPARTMENT OF COMMUNICATIONS.

LE PRÉSENT APPAREIL NUMÉRIQUE N'ÉMET PAS DE BRUITS RADIOÉLECTRIQUES DÉPASSANT LES LIMITES APPLICABLES AUX APPAREILS NUMÉRIQUES DE CLASSE A PRESCRITES DANS LE RÈGLEMENT SUR LE BROUILLAGE RADIOÉLECTRIQUE ÉDICTÉ PAR LE MINISTÈRE DES COMMUNICATIONS DU CANADA.

Information contained in this manual is company private to Acroprint Time Recorder Co., and shall not be modified, used, copied, reproduced or disclosed in whole or in part without the written consent of Acroprint.

Contents herein are current as of the date of publication. Acroprint reserves the right to change the contents without prior notice.

This manual has been carefully prepared to cover all aspects of this unit. However, if any explanations are inadequate, unclear, or difficult to understand, please contact Acroprint.

We recommend that you carefully read this manual to maximize the use of this unit.

© 2008 Acroprint Time Recorder Co.  
All Rights Reserved.

### Serial Number label for bottom of clock



5640 Departure Dr. • Raleigh, NC 27616 USA  
IN USA 800.334.7190

## ES700

Voltage: XXVAC 60Hz  
Wattage: XXA  
Serial No.:51nnnnnc



0 1 0 1 8 2 0 0 0 5 1 X X X X X X X



**LISTED**  
E220359

This equipment complies with Part 15 of FCC Rules. Operation is subject to the following two conditions: (1) This device may not cause harmful interference, and (2) must accept any harmful interference received, including interference that may cause undesired operation.

---

---

## Table of Contents

<b>Alert Definitions</b> .....	<b>iii</b>
<b>Precautions</b> .....	<b>iv</b>
<b>Introduction</b> .....	<b>1</b>
<b>Features</b> .....	<b>1</b>
<b>Equipment</b> .....	<b>2</b>
ES700 .....	2
Open and Close Unit .....	3
Power the Unit/Print Positioning .....	5
<b>Important Things to Remember When Using The ES700</b> .....	<b>6</b>
<b>Quick Start</b> .....	<b>7</b>
Atomic Synchronization .....	7
Set Time Zone (-5 EST, -6 CST, -7 MST, -8 PST) .....	7
Automatically Receive Atomic Signal .....	7
Turn DST OFF .....	7
<b>Program the Time Recorder</b> .....	<b>9</b>
<b>Settings</b> .....	<b>10</b>
Time .....	10
Date .....	11
12/24 Hour Format .....	12
Print Order .....	13
Year Digit .....	14
Hour/Minute .....	15
Leading Zero .....	17
Preset Comments .....	18
Language .....	19
Print Length .....	20
Print Method .....	21
Daylight Saving Time (DST) .....	23
Set Password .....	27
Enter Password .....	29
Cancel the Password .....	29



**Reset Factory Default Settings ..... 30**

**Wall Mounting ..... 32**

**Replacing the Ribbon Cassette ..... 33**

**Troubleshooting ..... 36**









**Specifications ..... 37**

---





---

## ALERT DEFINITIONS

For your safety and the protection of the unit, the following alerts are used throughout this manual.

READER ALERT	MEANING
	Alerts you to supplementary information.
	Alerts you to helpful tips (information given as a guide to action).
<b>IMPORTANT</b> 	Alerts you to supplementary information that is essential to the completion of a task.
<b>CAUTION</b>	Alerts you to possible data loss, breaches of security, or other more serious problems.
<b>WARNING</b>	Alerts you that failure to take or avoid a specific action might result in physical harm to you or to the hardware.
	Alerts you to stop immediately. Failure to do so will result in physical harm to you or to the hardware.
	Alerts you that improper handling may cause electrical shock resulting in serious injury or death.
	Alerts you not to disassemble or modify the unit.
	Alerts you to remove power cord from wall outlet.
	Alerts you “do not” perform an action.

## PRECAUTIONS

ALERT	DESCRIPTION
<p><b><u>IMPORTANT</u></b></p> 	<ul style="list-style-type: none"> <li>• Insert the power plug as far as it will go. Improper insertion of the plug may result in fire or electric shock.</li> </ul>
	<ul style="list-style-type: none"> <li>• Do not disassemble the unit. High voltage is present inside that may lead to an electric shock.</li> <li>• Do not modify the unit. Modifications may cause a fire and/or electric shock.</li> </ul>
	<ul style="list-style-type: none"> <li>• Do not use any voltage of the power source other than designated.</li> <li>• Do not share a single outlet with another plug. This may lead to a fire or electric shock.</li> <li>• Do not damage, break, or modify the power cord.</li> <li>• Do not put heavy objects on, pull, or forcefully bend the cord. These may damage the cord, possibly resulting in a fire or electric shock.</li> <li>• Do not plug or unplug the unit with a wet hand. This may lead to an electric shock.</li> <li>• Do not place the unit on an uneven or tilted surface. This may result in injuries due to the unit dropping or falling off.</li> <li>• Do not put a water-filled container or a metal object on top of the unit. If water is spilled or the metallic object slips inside, a fire or electric shock may occur.</li> <li>• Do not install the unit in a humid or dusty environment. This may result in a fire or electric shock.</li> <li>• Do not place the unit near a kitchen counter or humidifier. Oil, smoke, or steam generating from them may cause fire or electric shock.</li> <li>• Do not yank the power cord to disconnect from the outlet. Hold the plug with your hand to do so, or the cord may be damaged. This may lead to a fire or electric shock.</li> <li>• Do not insert or drop any other time card than specified into the slot. Such misuse may cause a fire or electric shock.</li> <li>• Do not come in contact with the print head. This may result in personal injury.</li> </ul>
	<ul style="list-style-type: none"> <li>• If any anomaly occurs, for example, heat or smoke is generated or an odor is emitted, unplug the unit <b>immediately</b> and contact your dealer for servicing. There is a danger that further use may cause a fire or electric shock.</li> <li>• If foreign matter should get in the unit (including a piece of metal, water, or liquid), disconnect the plug from the outlet <b>immediately</b> and contact your dealer for servicing. There is a danger that further use may cause a fire or electric shock.</li> <li>• Remove the line cord plug from the outlet before transferring the unit, or it may damage the cord. This may lead to a fire or electric shock.</li> <li>• If the unit should be dropped or the case is broken, unplug the unit and contact your dealer for servicing. Further use may lead to a fire or electric shock.</li> </ul>

---

---

## ***INTRODUCTION***

Thank you for purchasing an Acroprint Model ES700 Time Recorder. We are confident this unit will give you full satisfaction. Items such as the time and date are preset at the factory. After plugging in the power cord to the wall outlet, this unit can be used. However, we recommend reading this manual before you start using this unit.

## ***FEATURES***

**Main Applications:** Payroll/job cost recorder or time stamp.

- Atomic Synchronization Sets Time and Date Automatically
- Quartz Time Recorder
- Digital LCD (Date, Hour, Minute, Day of the Week)
- Perpetual Calendar
- Dot-Matrix Printer
- Automatic Daylight Saving Time (DST)
- Automatic Date, Month Year Change to 2099
- 3-way Print Activation
  - o Automatic
  - o Semi-Automatic
  - o Manual
- Durable Snap-in Ribbon Cartridge
- Adjustable Print Positions
- Prints in 4 languages
- Prints Date
- 13 Preset Comments
- Selectable 2 or 4 digit Year
- 12 or 24-Hour Format
- Regular Minute, Tenths, or Hundredths of an Hour
- Password Protection
- Wall or Desktop Mount

---

---

## EQUIPMENT

Unpack the unit and check its contents to ensure that the time recorder unit and all accessories shown below are included. If equipment has been damaged in transit, report the extent of damage to the transportation company and to Acroprint. Order replacement equipment, if necessary.

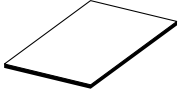

**ES700 Manual (1)**



**Keys (2)**

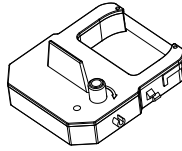

**Ribbon Cassette (1)  
Factory Installed**

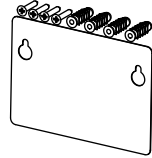

**Wall-Mount Fittings  
(4 Screws, 4 Mollies,  
1 Sheet)**



**Wall Brackets (2)  
(2 Screws)**

## ES700

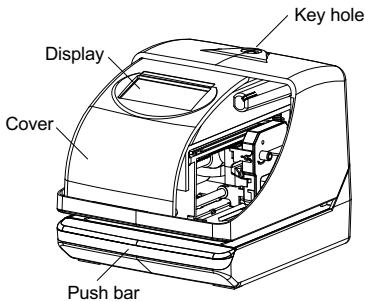

**Front View (with Cover)**

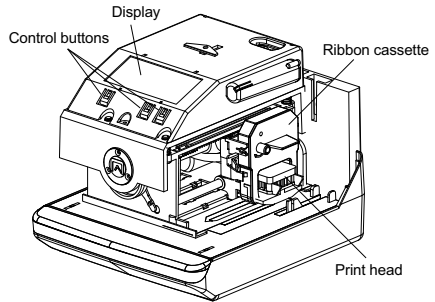

**Front View (without Cover)**

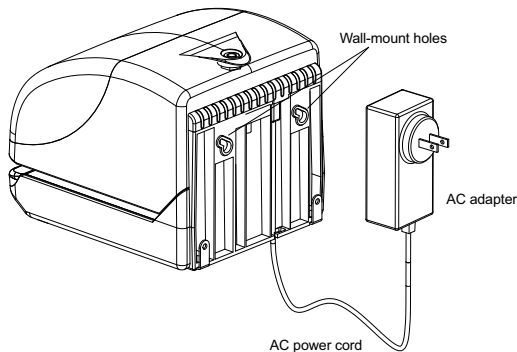

**Back View**



---

---

## Open and Close Unit

### Open Unit

Insert the key into the lock on cover of the unit. Turn the key in the clockwise position to unlock the unit. Remove the cover. Refer to [Open Unit](#) below.

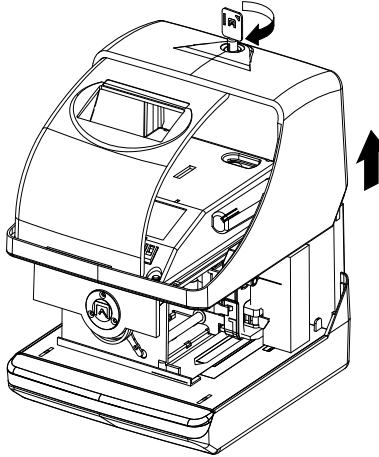

### Open Unit



When you open the unit for the first time, you must remove the **Protective Pad and Cardboard Insert**. Plug the AC Adapter into the back of the unit. Refer to [Remove Protective Pad and Cardboard Insert/Plug AC Adapter into Unit](#) on page 4.

### CAUTION

*Ribbon May Dislodge. To avoid damage to the printer, press the ribbon cartridge firmly into position after removing the protective pad. Refer to [Remove Protective Pad and Cardboard Insert/Plug AC Adapter into Unit](#) on page 4.*

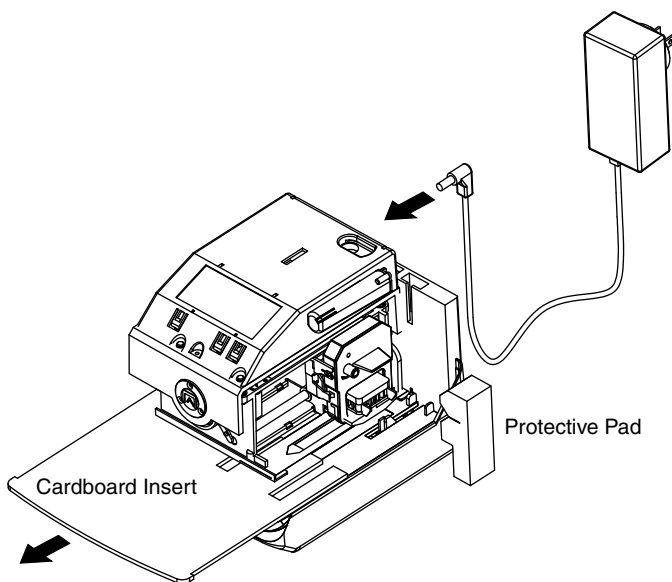

**Remove Protective Pad and Cardboard Insert/Plug AC Adapter into Unit**

### **Close Unit**

Replace the cover. Insert the key into the lock on the cover of the unit. Turn the key in the counter-clockwise position to lock the unit. Refer to [Close Unit](#) below.

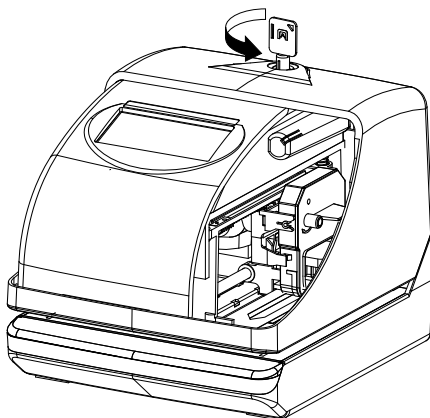

**Close Unit**

---

---

## Power the Unit/Print Positioning

Plug the transformer into the AC outlet. Insert a card to get a sample print. Refer to **Power the Unit** below.

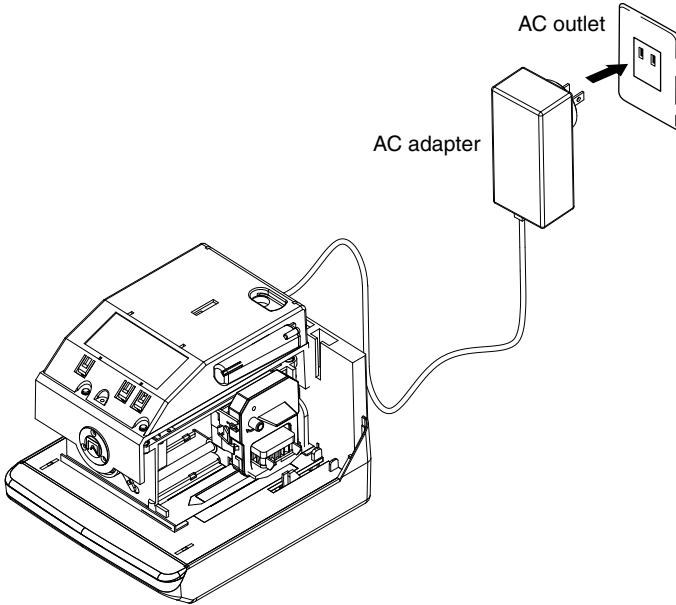

### Power the Unit

Print position from the card edge is adjustable by pressing and sliding the print position button located on the right outside bottom of the unit. Maximum distance from edge of form to print is approximately 1-3/16" (30 mm). Refer to **Print Position on Time Card** below.

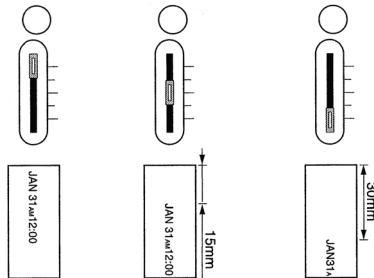

### Print Position on Time Card

---

---

## IMPORTANT THINGS TO REMEMBER WHEN USING THE ES700

### **IMPORTANT**



You must open the unit to make changes to the settings. After each use, replace the cover and lock it. Refer to “Open and Close Unit” on page 3.

After performing each procedure on the unit, remember to press **SET** until the unit returns to normal operation mode. To exit program mode anytime, press **SET** until the unit returns to normal operation mode.



When you are setting a digit or an option on the display, flashing means that it is ready to be changed. You must press **SELECT** until you reach the desired digit or option. Then press **SET** to lock the desired value in place.

Printing is always disabled while settings are being changed. Once the final **SET** has been completed in any given operation, printing is enabled.

---

---

## QUICK START

### Atomic Synchronization

The clock receives the NIST WWVB Signal which will automatically set the time and date. Refer to Atomic Synchronization Time Zones on page 8.

For more information about the WWVB Radio Signal (Atomic Signal), visit NIST's website at: [www.boulder.nist.gov](http://www.boulder.nist.gov).



Daylight Saving Time (DST) defaults to AUTOMATIC.

If you are in the EST Time Zone and observe DST, the Atomic Synchronization should work automatically after the AC cord has been plugged into the AC outlet overnight.

### Set Time Zone (-5 EST, -6 CST, -7 MST, -8 PST)

1. Press **SELECT** until the arrow points to Time Zone.
2. Press **CHANGE** until your Time Zone appears (see Time Zones on page 8).
3. Press **SET**.

### Automatically Receive Atomic Signal

1. Plug the transformer into the AC outlet overnight.
2. If the Atomic Clock Symbol indicator is on in the morning, your clock is receiving the atomic clock signal and the time and date should be set properly.



#### Atomic Synchronization Symbol Indicator

3. If you did not receive the atomic signal, try repositioning the clock or set the unit manually as described above.



If you do not observe DST, follow the procedure below to turn DST off.

### Turn DST OFF

1. Press **SELECT** (twice). Arrow points to DST.
2. Press **CHANGE** until "2" is displayed.
3. Press **SET**.

**Atomic Synchronization Time Zones**  
**Default = ES-05**

DISPLAY TIME ZONE	DESCRIPTION
12	
11	
10	
09	
08	
07	
06	
05	
04	
03	
02	
01	
00	Greenwich
-01	
-02	
-03	
-04	Atlantic Standard Time
ES-05 (Default)	Eastern Standard Time
CS-06	Central Standard Time
-07	Mountain Standard Time
PS-08	Pacific Standard Time
AS-09	Alaska Standard Time
HS-10	Hawaiian Standard Time
-11	
-12	

## PROGRAM THE TIME RECORDER

### **IMPORTANT**



*Most of the procedures in this manual are performed from the Time Recorder menu. Refer to Time Recorder Menu below. Refer to Time Recorder Function Buttons below.*

Press **SELECT**. The unit changes into the program mode showing ▲ on the display positioned under the "TIME" mark.

**PRINT ORDER**

1. M.D.H.Min
2. D.M.H.Min
3. M.D.Y.H.Min
4. D.M.Y.H.Min
5. Y.M.D.H.Min
6. Y.M.D.H.Min.S
7. D.H.Min
8. DOW.D.H.Min
9. Y.M.D
10. M.D
11. DOW.D.M.Y
12. C.M.D.Y
13. C.D.M.Y
14. C.Y.M.D
15. M.D.Y.C
16. D.M.Y.C
17. Y.M.D.C
18. C.D.H.Min

Y=Year  
M=Month  
D=Date  
DOW=Day of the week  
H=Hour  
Min=Minute  
S=Second  
C=Comment

**PRINT STYLE**

1. 2.Digits
2. 4.Digits
1. 12hour
2. 24hour
1. ZERO Disabled
2. ZERO Enabled
1. RCVD
2. SENT
3. IN
4. OUT
5. CFMD
6. FILED
7. PAID
8. USED
9. FAXED
10. VOID
11. ORIGN
12. APR'D
13. CML'D

CC:Minute  
1. 1/60  
2. 1/100  
3. 1/20  
4. 1/10

**DISPLAY**

AA:Sec. 1. 12hour  
BB:Hour 2. 24hour  
CC:Min. CC:Date

**TIME** **DATE** **HOUR** **PRINT ORDER** **YEAR DIGIT** **HOUR MIN.** **LEADING ZERO** **COMMENT**

TIME: SU MO TU WE TH FR SA

**L.C.D.**

RR-BB-CC

Reference for programming

**PASSWORD**

**TIME ZONE**

-12-0-12

**D.S.T. END**

AA:Year  
BB:Month  
CC:Date

**D.S.T.**

1. Automatic
2. Off
3. Manual

**D.S.T. START**

**PRINT DIRECTION**

**PRINT ACTIVATION**

BB:Print Direction

1. Right
2. Left

CC:PrintActivation

1. Automatic
2. Semi-automatic
3. Manual
4. Combination

**LANGUAGE**

1. ENGLISH
2. FRENCH
3. SPANISH
4. PORTUGUESE

**PRINT LENGTH**

- 1-6

**SELECT** **CHANGE** **SET**

**DAYLIGHT SAVING TIME** **PRINT METHOD**

### Time Recorder Menu

#### Time Recorder Function Buttons

CONTROL	FUNCTION
SELECT	Press <b>SELECT</b> to choose the desired program setting mode. The selected program mode is indicated by ▲ on the display.
CHANGE	Press <b>CHANGE</b> to cycle through the options.
SET	Press <b>SET</b> to set the option. After an option has been set, always press <b>SET</b> again to return the unit to normal operation mode.

---

---

## SETTINGS

### Time



Set the Time Zone before setting the Time (see Set Time Zone on page 7). Changing the Time Zone will change the Time.

**Example:** Change the time from 9:08 AM to 10:09 AM.

1. Press **SELECT** until the ▲ is under the "TIME" mark.
2. "Hour" flashes.

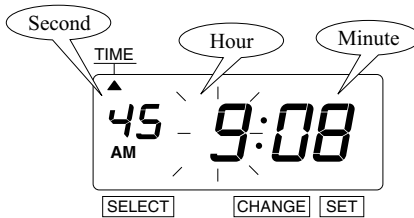

#### Change Hour

1. Press **CHANGE** until the Hour is "10".
2. Press **SET**.
3. The flashing changes from "Hour" to "Minute".

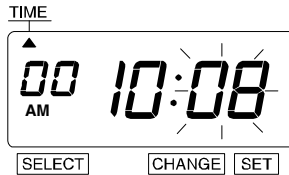

#### Change Minute

1. Press **CHANGE** until the Minute is "09".
2. Press **SET**.
3. The "Second" starts to run from "00".

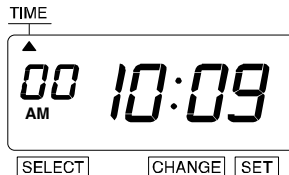



---

---

## Date

**Example:** Change the date from September 20, 2007 to October 21, 2008.

1. Press **SELECT** until the ▲ is under the "DATE" mark.
2. "Year" flashes.

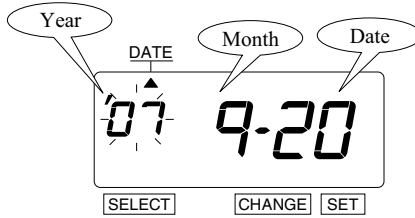

### *Change Year*

1. Press **CHANGE** until the Year is "08".
2. Press **SET**.
3. The flashing changes from "Year" to "Month".

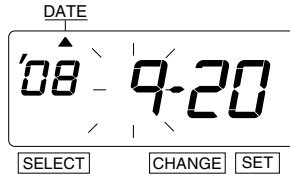

### *Change Month*

1. Press **CHANGE** until the Month is "10".
2. Press **SET**.
3. The flashing changes from "Month" to "Date".

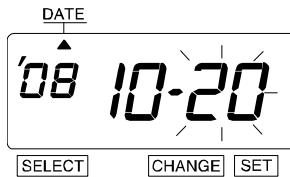

## Change Date

1. Press **CHANGE** until the Date is "21".
2. Press **SET**.

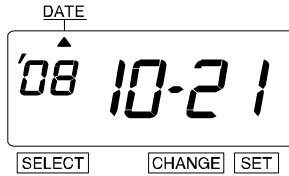

## 12/24 Hour Format

**Example:** Change the hour format from 12 hour format to 24 hour format.

1. Press **SELECT** until the ▲ is under the "HOUR" mark.
2. The flashing digit indicates "Hour Display Format Options".

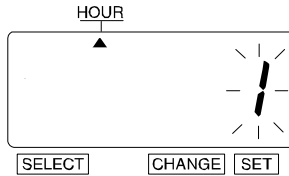

## Change Hour

1. In this example, press **CHANGE** until the option is "2" (24 Hour Format). Refer to Hour Display Options below.
2. Press **SET**.

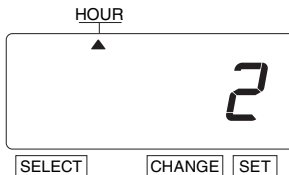

### Hour Display Options

OPTION	HOUR DISPLAY FORMAT OPTIONS	DISPLAY
1	12 Hour	PM 3:00
2	24 Hour	15:00

---

---

## Print Order

**Example:** Set the print order to "Month, Date, Year, Hour, Minute".

1. Press **SELECT** until the ▲ is under the "PRINT ORDER" mark.
2. The flashing digit indicates "Print Order Options".

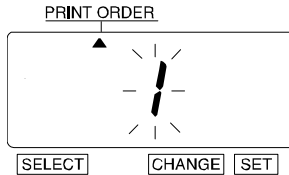

3. Refer to Print Order Options on page 14.
4. In this example, press **CHANGE** until the option is "3" (M.D.Y.H.Min.).
5. Press **SET**.

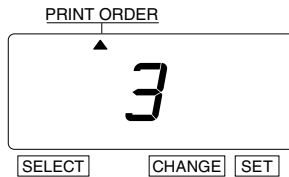

### Legend

Y = Year
M = Month
D = Date
DOW = Day of the Week
H = Hour
Min = Minute
S = Second
C = Comment

## Print Order Options

OPTION	PRINT ORDER OPTIONS	PRINT EXAMPLE
1	M.D.H.Min	JAN 31 AM 10:00
2	D.M.H.Min	31 JAN AM 10:00
3	M.D.Y.H.Min	JAN 31 '08 AM 10:00
4	D.M.Y.H.Min	31 JAN '08 AM 10:00
5	Y.M.D.H.Min	'08 JAN 31 AM 10:00
6	Y.M.D.H.Min.S	'08 JAN 31 AM 10:00:00
7	D.H.Min	31 AM 10:00
8	DOW.D.H.Min	TH, 31 AM 10:00
9	Y.M.D	'08 JAN 31
10	M.D	JAN 31
11	DOW.D.M.Y	TH, 31 JAN '08
12	C.M.D.Y	SENT JAN 31 '08
13	C.D.M.Y	SENT 31 JAN '08
14	C.Y.M.D	SENT '08 JAN 31
15	M.D.Y.C	JAN 31 '08 SENT
16	D.M.Y.C	31 JAN '08 SENT
17	Y.M.D.C	'08 JAN 31 SENT
18	C.D.H.Min	SENT 31 AM 10:00

## Year Digit

### *Change Year Digit*

If you have selected the unit to print the year, this allows you to choose the number of digits in the year (two or four).

**Example:** Change the Year imprint to 4 digits.

1. Press **SELECT** until the ▲ is under the "YEAR DIGIT" mark.
2. The flashing digit indicates "Year Digit Options".

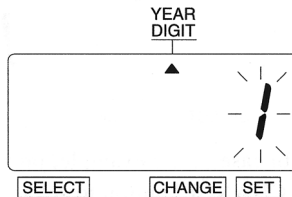

3. In this example, press **CHANGE** until the option is "2" (4 Digits). Refer to Year Digit Options below.
4. Press **SET**.

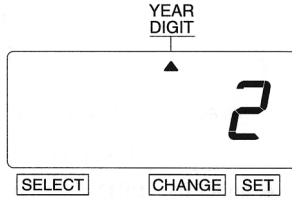

### Year Digit Options

OPTION	YEAR DIGIT OPTIONS	PRINT EXAMPLE
1	2 Digits	JAN 31 '08 AM 10:00
2	4 Digits	JAN 31 2008 AM 10:00

## Hour/Minute

### Change Hour/Minute

**Example:** Set the "Hour" and "Minute" to 24 Hour and 1/100 Min.

1. Press **SELECT** until the ▲ is under the "HOUR/MIN." mark.
2. The flashing digit indicates "Type of Hour".

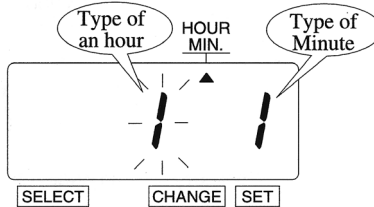

3. In this example, press **CHANGE** until the option is "2" (24 Hour). Refer to Type of Hour Options below.
4. Press **SET**.

### Type of Hour Options

OPTION	TYPE OF HOUR	PRINT EXAMPLE
1	12 Hour	JAN 31 PM 3:00
2	24 Hour	JAN 31 15:00

5. The flashing digit indicates from "Hour" to "Minute".

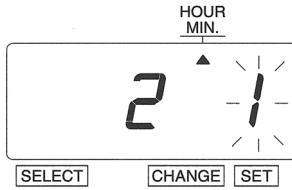

6. In this example, press **CHANGE** until the option is "2" (1/100 Min.). Refer to Type of Minute Options below.

7. Press **SET**.

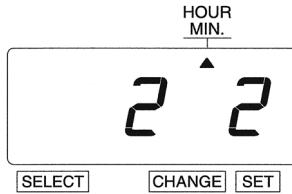

### Type of Minute Options

OPTION	TYPE OF MINUTE	PRINT EXAMPLE
1	1/60 Min	JAN 31 2008 10:10
2	1/100 Min	JAN 31 2008 10.17
3	1/20 Min (=5/100 Min)	JAN 31 2008 10.15
4	1/10 Min	JAN 31 2008 10.1

---

---

## Leading Zero

### Change Leading Zero

**Example:** Set the Leading Zero to "ZERO Disabled".

1. Press **SELECT** until the ▲ is under the "LEADING ZERO" mark.
2. The flashing digit indicates "Leading Zero Options".

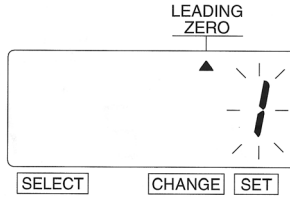

3. In this example, press **CHANGE** until the option is "1" (Leading Zero Option disabled). Refer to Leading Zero Options below.
4. Press **SET**.

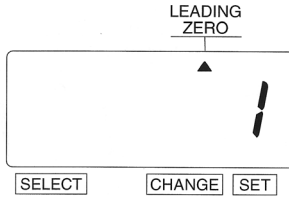

### Leading Zero Options

OPTION	LEADING ZERO	PRINT EXAMPLE
1	Zero Disabled	JAN 1 PM 3:00
2	Zero Enabled	JAN 01 PM 03:00

## Preset Comments



Prior to enabling Preset Comments, refer to [Print Order Options on page 14](#) to ensure that you have set up the print order options to allow Preset Comments (options 12 through 18 allow Preset Comments).

**Example:** Change the comment to "SENT".

1. Press **SELECT** until the ▲ is under the "COMMENT" mark.
2. The flashing digit indicates "Comment Options".

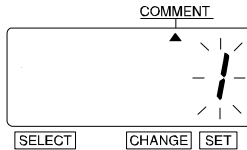

### Change Comment Options

1. In this example, press **CHANGE** until the option is "2" (SENT). Refer to [Preset Comment Options](#) below.
2. Press **SET**.

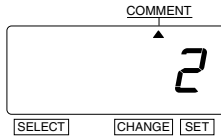

### Preset Comment Options

OPTION	COMMENT OPTIONS	PRINT EXAMPLE
1	RCVD (Received)	JAN 31 '08 RCVD
2	SENT	JAN 31 '08 SENT
3	IN	JAN 31 '08 IN
4	OUT	JAN 31 '08 OUT
5	CFMD (Confirmed)	JAN 31 '08 CFMD
6	FILED	JAN 31 '08 FILED
7	PAID	JAN 31 '08 PAID
8	USED	JAN 31 '08 USED
9	FAXED	JAN 31 '08 FAXED
10	VOID	JAN 31 '08 VOID
11	ORIGN (Original)	JAN 31 '08 ORIGN
12	APR'D (Approved)	JAN 31 '08 APR'D
13	CMPL'D (Completed)	JAN 31 '08 CMPL'D



---

---

## Language

This setting is available if you select "Month", "Day of the Week", or "Comment" in previous "PRINT ORDER".

**Example:** Change the print language to French.

1. Press **SELECT** until the ► is beside the "LANGUAGE" mark.
2. The flashing digit indicates "Print Language Options".

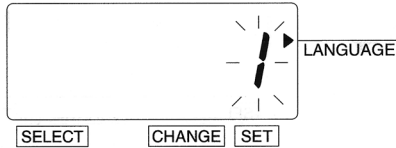

3. In this example, press **CHANGE** until the option is "2" (French). Refer to [Language Options](#) table below.
4. Press **SET**.

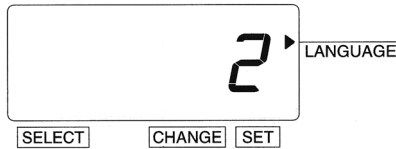

### Language Options

OPTION	PRINT LANGUAGE OPTIONS	PRINT EXAMPLE
1	ENGLISH	TH 25 DEC '08 OUT 31 10:00
2	FRENCH	JE, 25 DEC '08 SORT 31 10:00
3	SPANISH	JU, 25 DIC '08 SAL 31 10:00
4	PORTUGUESE	QI, 25 DEZ '08 SAIDA 31 10:00

---

---

## Print Length

The print length default is 4. You may select from six (1-6) font sizes (refer to Print Length Examples (1-6) below).

1	JAN 11 PM4:13	4	JAN 11 PM4:13
2	<b>JAN 11 PM4:14</b>	5	JAN 11 PM4:13
3	JAN 11 PM4:14	6	JAN 11 PM4:12

### Print Length Examples (1-6)



If the font size is too large to print, the font will revert to a smaller size before printing correctly.

**Example:** Change the print length from the 4 to 2.

1. Press **SELECT** until the ► is beside the "PRINT LENGTH" mark.
2. The flashing digit indicates "Print Length Options".

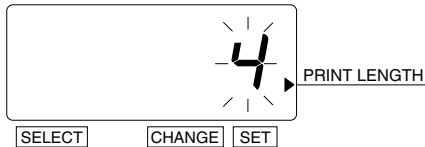

3. In this example, press **CHANGE** until the option is "2".  
Refer to [Print Length Examples \(1-6\)](#) above.
4. Press **SET**.

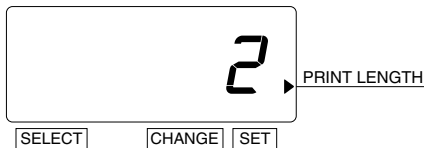

## Print Method

**Example:** Change the print direction to "Left" and the print activation to "Manual".

1. Press **SELECT** until the ▼ is above the "PRINT DIRECTION/PRINT ACTIVATION" mark.
2. The flashing digit indicates "Print Direction Options".

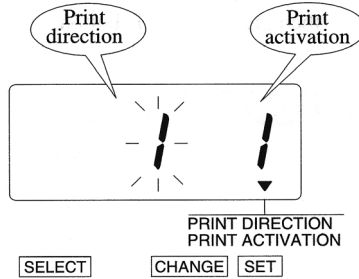

### Change Print Direction

1. In this example, press **CHANGE** until option is "2" (Left-Hand Margin Form). Refer to Print Direction Options below.
2. Press **SET**.

#### Print Direction Options

OPTION	PRINT DIRECTION OPTIONS
1	Right-Hand Margin Form
2	Left-Hand Margin Form

3. The flashing digit changes from "Print Direction" to "Print Activation".

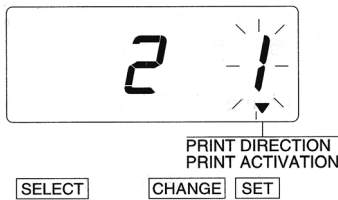

### Change Print Activation

1. In this example, press **CHANGE** until the option is "3" (Manual). Refer to Print Activation Options below.
2. Press **SET**.

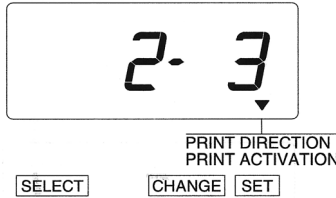

### Print Activation Options

OPTION	PRINT METHOD OPTIONS
1	Automatic – Allows you to print by inserting a card or piece of paper.
2	Semi-Automatic – Allows you to print by pressing the push bar only when a card or piece of paper is inserted (prints only if the card or form reaches the sensor). Refer to <a href="#">Press Push Bar</a> below.
3	Manual – Allows you to print by pressing the push bar (even if the card or paper does not reach the sensor). Refer to <a href="#">Press Push Bar</a> below.
4	Combination – Allows you to print by pressing the push bar or inserting a card or piece of paper. Refer to <a href="#">Press Push Bar</a> below.

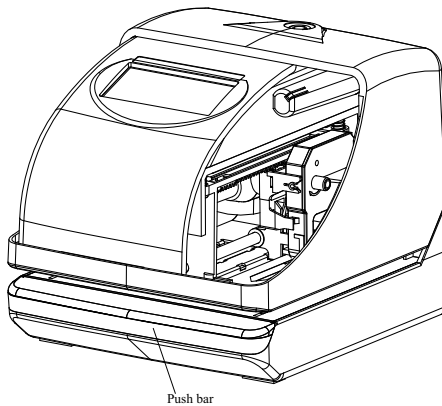

### Press Push Bar

---

---

## Daylight Saving Time (DST)

DST begins on the second Sunday in March and ends on the first Sunday in November. Refer to DST below.

At 2:00 AM on the first day of DST, the clock automatically gains one hour to show 3:00 AM.

At 2:00 AM on the last day of DST, the clock automatically loses one hour to show 1:00 AM.



Not all places in the US observe DST.

### DST

YEAR	DST BEGINS 2 AM (2ND SUNDAY IN MARCH)	DST ENDS 2 AM (1ST SUNDAY IN NOVEMBER)
2008	3/9	11/2
2009	3/8	11/1
2010	3/14	11/7
2011	3/13	11/6
2012	3/11	11/4
2013	3/10	11/3
2014	3/9	11/2
2015	3/8	11/1



DST Mode may be set to one of the following options:

OPTION	DESCRIPTION
1	<b>Automatic</b> – Automatically sets from the atomic signal.
2	<b>Off</b> – DST is off.
3	<b>Manual</b> – The customer manually sets the DST feature (refer to “Manually Setting DST” on page 24).

---

---

## Manually Setting DST

### Example:

Start Date – Sunday, March 9, 2008

End Date – Sunday, November 2, 2008

In this example, the unit remembers the **Start Date** as the second Sunday in March and the **End Date** as the first Sunday in November. Once the unit is set, it automatically updates the settings every year thereafter. No further manual setting is necessary.

1. Press **SELECT** until the ▼ is above the "DST" mark.

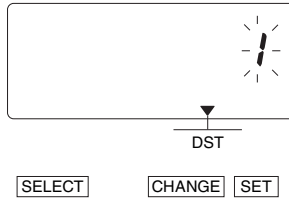

2. Press **CHANGE** until the option is "3" (Manual).
3. Press **SET**.
4. The flashing digit indicates "Year".

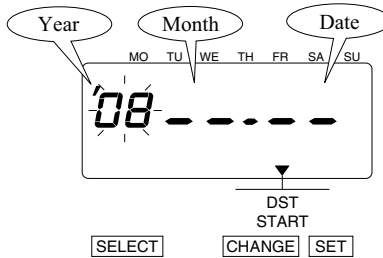

## Start Date

### Change the Year

1. In this example, the "Year" is not being changed. Refer to DST on page 23.

2. Press **SET**.

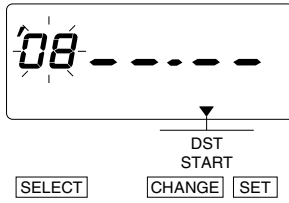

3. The flashing changes from "Year" to "Month".

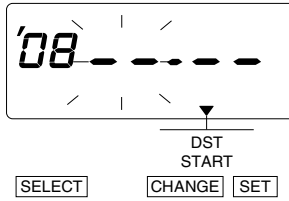

### Change the Month

1. In this example, press **CHANGE** until the month is "3" (March). Refer to DST on page 23.
2. Press **SET**.

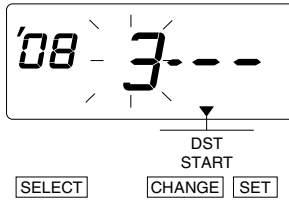

3. The flashing changes from "Month" to "Date".

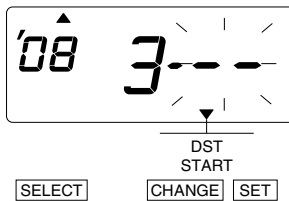

---

---

## Change the Date

1. In this example, press **CHANGE** until the date is "09". Refer to DST on page 23.
2. Press **SET**.
3. The "Starting Date" of the display changes from flashing to steady and the ▲ mark is displayed under "SU".

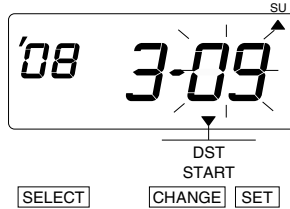

## End Date

### Change the Year

1. Press **SELECT** until the ▼ is above the "DST END" mark.
2. The flashing digit indicates "Year".
3. In this example, the "Year" is not being changed. Refer to DST on page 23.
4. Press **SET**.

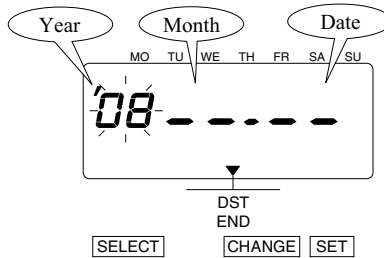

5. The flashing changes from "Year" to "Month".

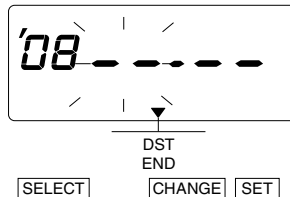



---

---

## Change the Month

1. In this example, press **CHANGE** until the month is "11" (November). Refer to DST on page 23.
2. Press **SET**.
3. The flashing changes from "Month" to "Date".

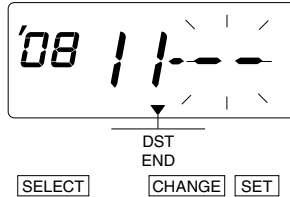

## Change the Date

1. In this example, press **CHANGE** until the date is "02". Refer to DST on page 23.
2. Press **SET**.
3. The "Ending Date" of the display changes from flashing to steady and the ▲ mark is displayed under "SU".

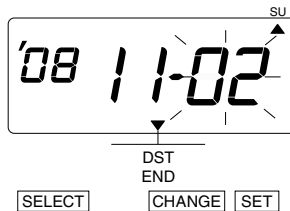

## Set Password

Once the password is set, you must enter it before changing any settings. Refer to "Enter Password" on page 29.



You may choose any 4-digit number from 0001 to 9998. Numbers "0000" and "9999" are not valid passwords.

All settings must be reset if you forget the password. Refer to "Reset Factory Default Settings" on page 30.

**Example:** Set the Password to "1234".

1. Press **SELECT** until the ▼ is above the "PASSWORD" mark.

---

---

2. The first two digits flash.

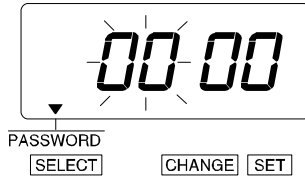

*Change the First Two Digits*

1. In this example, press **CHANGE** until the first two digits are "12".
2. Press **SET**.
3. The flashing changes to the last two digits.

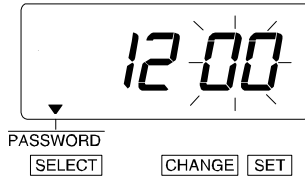

*Change the Last Two Digits*

1. In this example, press **CHANGE** until the last two digits are "34".
2. Press **SET**.

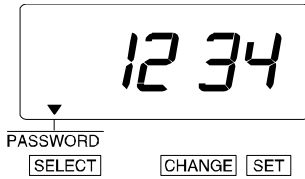

---

---

## Enter Password



Once the password is set, you must enter the current password before changing any settings.

1. Press **SELECT** twice.
2. The numbers "9999" are displayed and the first two digits flash.

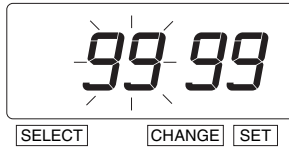

### *Set the First Two Digits*

1. In this example, press **CHANGE** until the first two digits are "12".
2. Press **SET**.
3. The flashing changes to the last two digits.

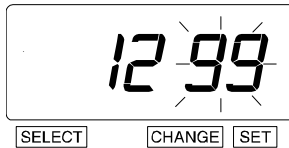

### *Set the Last Two Digits*

1. In this example, press **CHANGE** until the last two digits are "34".
2. Press **SET** twice.

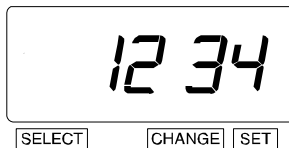

## Cancel the Password

The code "0000" must be entered to cancel password activation.

---

---

## **RESET FACTORY DEFAULT SETTINGS**

Press the reset switch with a pointed object to return all settings to the factory default settings. Refer to Press Reset Button below. Refer to Factory Default Settings on page 31.

**IMPORTANT**



*All custom settings will be deleted and will revert to the factory default settings when the reset switch is pressed.*

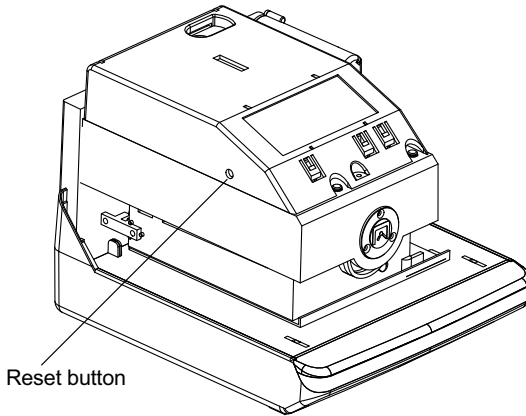

**Press Reset Button**

### Factory Default Settings

FEATURE	FACTORY DEFAULT SETTINGS
Time	Default = 8:00 AM
Date	Default = 01/01/2008
12/24 Hour Format	Default = 1 (12 hours format, AM/PM)
Print Order	Default = 1 (M.D.H.Min)
Year Digit	Year Digit Default = 1 (2 digits)
Hour/Minute	Hour Default = 1 (12 hours) Minute Default = 1 (60 minutes format)
Leading Zero	Leading Zero Default = 1 (zero disabled)
Pre-Programmed Comments	Default = 1 (RCVD)
Language	Default = 1 (English)
Print Length	Print Length Default = 4
Print Method	Print Direction Default = 1 (right-hand margin form) Print Activation Default = 1 (automatic)
Daylight Saving Time	Default = 1 (automatic)
Time Zone	-05, Eastern Standard Time
Password	Default = 0000

---

---

## WALL MOUNTING

**CAUTION** *The ES700 should be mounted on 1/2 inch drywall using two ST 4x20 screws and fasteners.*

1. Install the supplied wall-mount screws by using the template. Refer to Install Wall-Mount Screws below.



Be sure to keep about 6mm (1/4") of the screw head away from the wall. The recommended height from the floor to the bottom of the unit is 45".

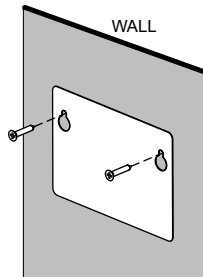

### Install Wall-Mount Screws

2. Open the unit. Refer to “Open Unit” on page 3.
3. Hang the unit on the wall and install Wall Mount Brackets. Refer to Hang Unit below.

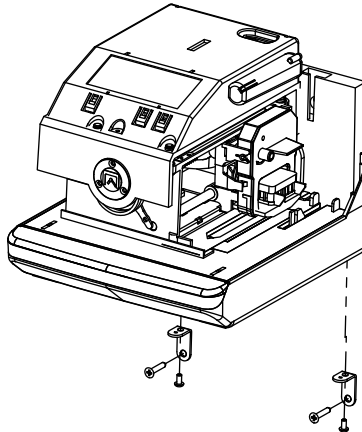

### Hang Unit

4. Close the unit. Refer to “Close Unit” on page 4.

---

---

## **REPLACING THE RIBBON CASSETTE**

1. Open the unit. Refer to “Open Unit” on page 3.
2. Hold the ribbon cassette by its tab and pull the ribbon cassette straight out to remove it. Refer to Remove Ribbon Cassette below.

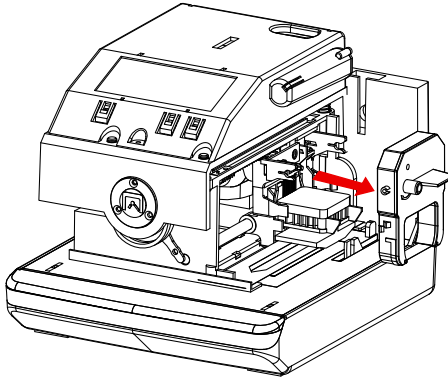

**Remove Ribbon Cassette**

3. Turn the knob of the new ribbon cassette in the direction of the arrow (clockwise) to tighten the ribbon. Refer to Tighten Ribbon Cassette below.

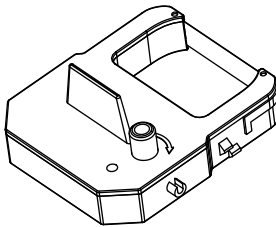

**Tighten Ribbon Cassette**

- 
- 
4. Install the ribbon cassette inside the unit as shown. Refer to [Install Ribbon Cassette](#) below.  
Push the ribbon cassette until it snaps into position.



Turning the knob on the ribbon cassette may make installation easier.

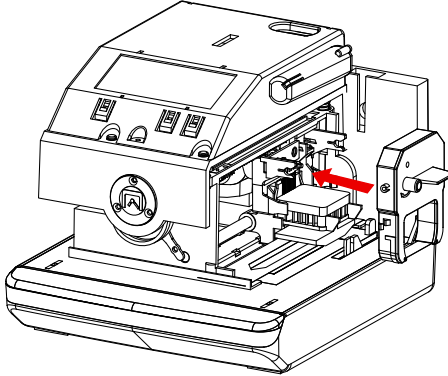

### Install Ribbon Cassette



Install the ribbon cassette so that the ribbon is between the print head and the ribbon mask. Printing will not function properly if the ribbon is placed behind the ribbon mask. Refer to [Install Ribbon Cassette Between Print Head and Ribbon Mask](#) below.

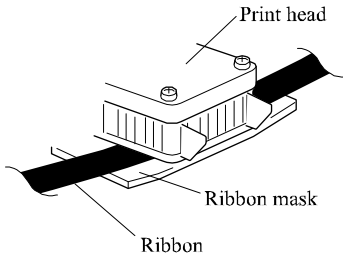

### Install Ribbon Cassette Between Print Head and Ribbon Mask



- 
- 
5. Turn the knob of the ribbon cassette in the direction of the arrow to tighten the ribbon.  
Refer to **Tighten Ribbon Cassette** below.

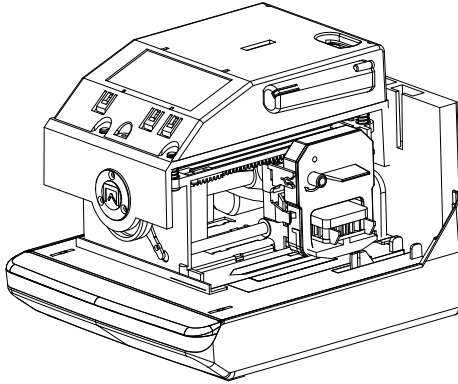

**Tighten Ribbon Cassette**

6. Close the unit. Refer to “Close Unit” on page 4.

## TROUBLESHOOTING

### Error No. Appears

ERROR NO.	ERROR CONTENTS	CORRECTIVE ACTION
E-00	CPU error	Contact Acroprint at (800) 334-7190 (USA).
E-01	The remaining life of lithium battery for memory back-up is short.	
E-05	The card is not inserted in the Time Recorder properly.	Correctly insert the card.
E-30	Cannot print, the printer motor or home position sensor is not normal.	Make sure that the ribbon cassette is correctly inserted in place.
E-38	Cannot print, the printer head motor or the sensor does not operate properly.	Press the push bar.
E-40	Incorrect password	Enter the correct password again.
E-41	DST setting mistake	Confirm the correct starting and ending dates of daylight saving time and enter again.
E-49	Setting data you entered is not usable	Refer to your manual on the page related to the item you want to set and enter correct setting data.

### Other Failures

ERROR	CORRECTIVE ACTION
Unit does not operate	Ensure the power cord is properly plugged into the wall outlet and power is available.
Unit does not print	Ensure the ribbon cassette is installed correctly and the proper print method is set.
Card is jammed	Press the push bar and try to pull out the card or paper at the same time.

---

---

## SPECIFICATIONS

Clock Accuracy	Monthly accuracy $\pm$ 15 sec. (at ordinary temperatures)
Calendar	Year up to 2099. Automatically adjusted to leap years, 31-day months and months with 30 or fewer days, and the days of the week.
Printing System	Dot matrix
Power Failure Compensation	Five years of cumulative power failure hours after the date of shipment.
Operating Environment	Temperature: $-5^{\circ}$ to $+45^{\circ}\text{C}$ , $+25^{\circ}$ to $+113^{\circ}\text{F}$ Humidity: 20 to 80%, no condensation The unit operates normally at temperatures of $5^{\circ}\text{C}$ ( $25^{\circ}\text{F}$ ) or below, but the print density and reaction of the liquid crystal display are inferior to those at normal temperature operation.
Dimensions	6.45" (w) x 5.63" (h) x 6.77" (d) 164 (w) x 143 (h) x 172 (d) mm
Weight	Approx. 4.4 lbs. with AC Adapter (2.0 kg with AC Adapter)
Rating	AC Adapter: I/P 120 VAC 60 Hz O/P 15 V 1300 mA

**IMPORTANT**



*Use only the supplied AC Adapter with this unit.*



# Product Registration Card

Mail, Fax to 919.850.0720, or Register Online at [www.acroprint.com](http://www.acroprint.com)

**ES700**

Model No. \_\_\_\_\_

Serial No. \_\_\_\_\_

First Name \_\_\_\_\_

Last Name \_\_\_\_\_

Title \_\_\_\_\_

Company Name \_\_\_\_\_

Address \_\_\_\_\_

City \_\_\_\_\_

State \_\_\_\_\_

Zip \_\_\_\_\_

Daytime Phone with Area Code \_\_\_\_\_

Email Address \_\_\_\_\_

Fax# \_\_\_\_\_

Purchased From \_\_\_\_\_

Purchase Date \_\_\_\_\_

So that we may serve you better, please indicate your primary business activity:

Manufacturing

Hotel/Motel

Wholesale

Banking/Financial

Retail

Medical/Dental

Government

Construction

University/School

Other \_\_\_\_\_

Restaurant

Number of Employees using this product:

1-10

50-75

11-25

76-100

26-49

100+

Annual Sales in dollars:

Under \$100,000

\$500,000 – 1,000,000

\$100,000 – 250,000

\$1,000,000 – 5,000,000

\$250,000 – 500,000

\$5,000,000+

Are you interested in receiving information on any other Acroprint products:  
(check all that apply)

Manual Time Clocks

Human Resources Software

Electronic Time Clocks

Data Collection Terminals

Time Stamps

Biometrics

Time and Attendance Software

How likely is it that you would recommend Acroprint to a friend or colleague?

0    1    2    3    4    5    6    7    8    9    10

Not at all likely

Neutral

Extremely likely

Cut Here







5640 Departure Drive  
Raleigh, NC 27616 USA  
919.872.5800  
800.334.7190 (in USA)  
919.850.0720 (Fax)  
[www.acroprint.com](http://www.acroprint.com)  
[sales@acroprint.com](mailto:sales@acroprint.com)